

ORTHOPHOTOGRAPHY ACQUISITION

HOUSE COMMITTEE ON CORRECTIONS & INSTITUTIONS

FEBRUARY 4, 2021

JOHN E. ADAMS

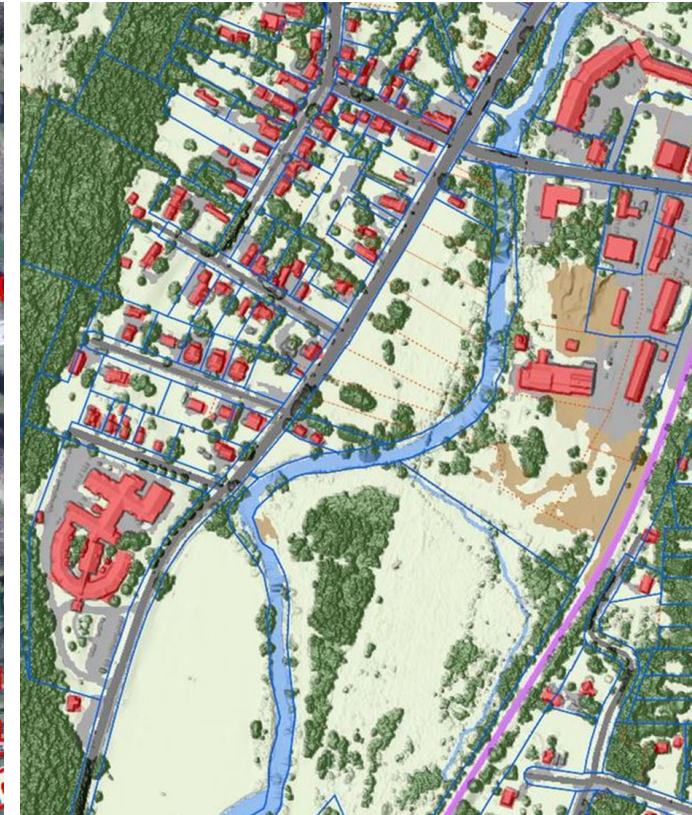

Orthophotographic Imagery

An orthophoto is an aerial photograph or geometrically corrected ("orthorectified") such that the scale is uniform: the photo or image follows a given map projection. Unlike an uncorrected aerial photograph, an orthophoto can be used to measure true distances, because it is an accurate representation of the Earth's surface, having been adjusted for topographic relief, lens distortion, and camera tilt.





Orthophotographic Imagery

2021-2025 ACQUISITION PLAN

- Annual request of \$125k

SPECIFICATIONS

- Color and Infrared
- Leaf-Off, No Snow, No Clouds
- Accuracy within 73.4cm meeting NSSDA accuracy
- 30cm resolution (15cm targeted area)
- Independent QA/QC

History of Orthophotos in Vermont

1974
Orthophotographs

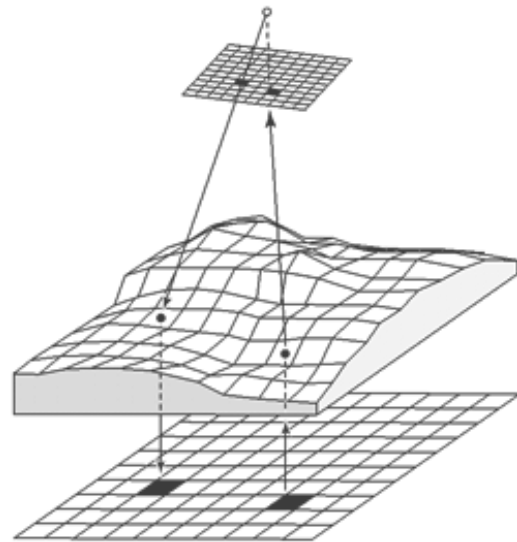

Figure 2 - Color Infrared showing bare earth

2016
VCGI Officially
takes over duties
from Tax Dept

2011
Color Infrared

1994
Digital
Orthophotos



1968
Vermont Mapping
Program





50cm resolution



15cm resolution



Orthophotography Workgroup

Members

- Steve Sharp - VCGI
- Erik Engstrom - ANR
- Johnathan Croft + Brad Herring - VTrans
- Jeremy McMullen + Tyler Hermanson - E911
- Pam Brangan - VADPA/Regional Planning Commissions
- Jarlath O'Neil-Dunne (UVM)
- Bill Hegman (Middlebury)
- Mark Day – Vermont Society of Land Surveyors

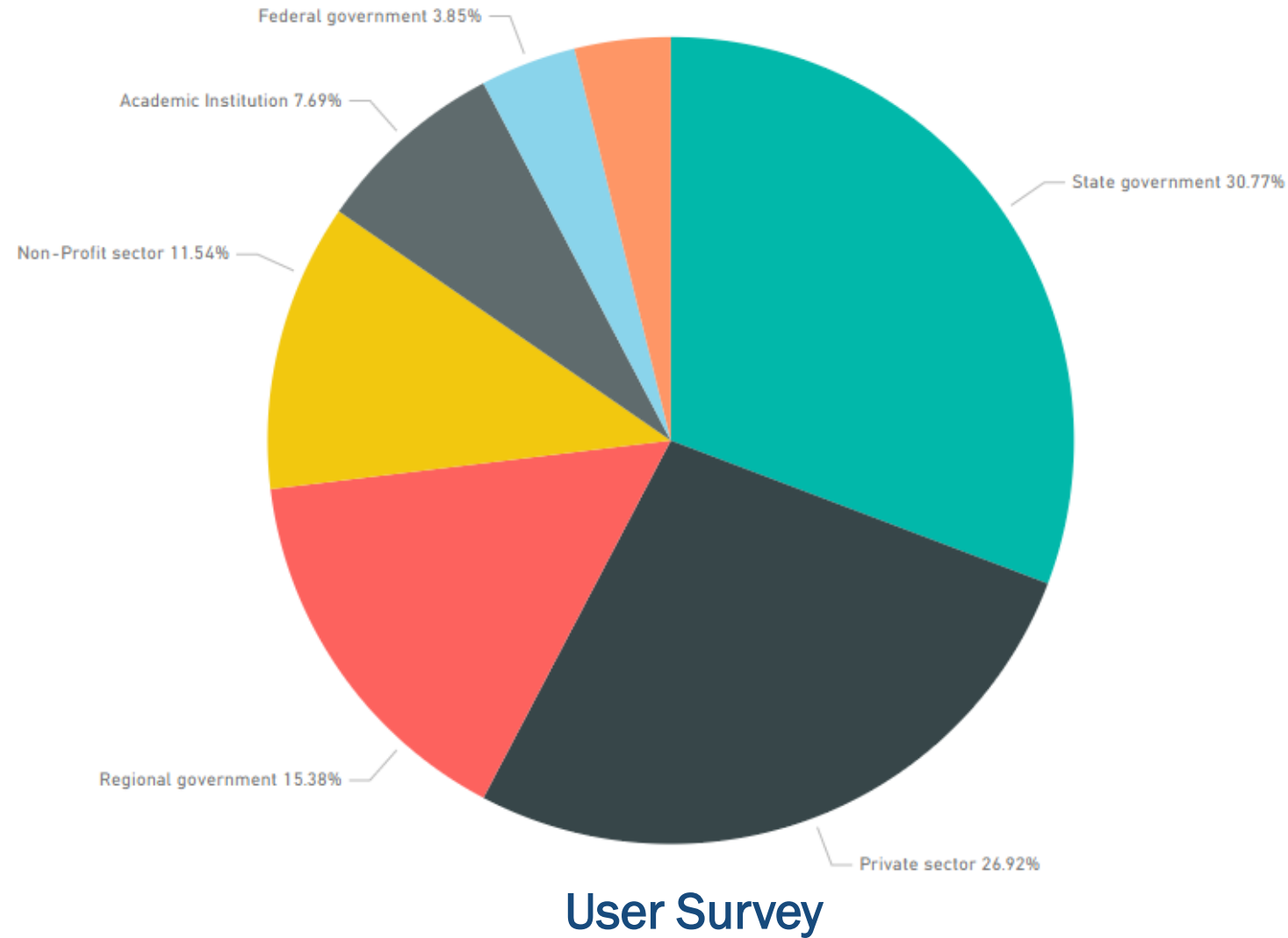

Availability and Users

AVAILABILITY

- Free for use by all (including commercial uses)
- Imagery available for download & web service
- Uncompressed available on hard drives

USERS

- State Agencies (AOT, DPS, Tax, ANR, AHS, E911, PSD, ACCD)
- Municipalities, RPCs and Federal Agencies
- Academia
- Private Sector (Engineers, Surveyors, Foresters, Attorneys, Landscape Architects Ecologists, and many more.)



[Download Imagery](#)

Historic Imagery



[Learn more & access 1962 imagery](#)



Spatial Data Infrastructure

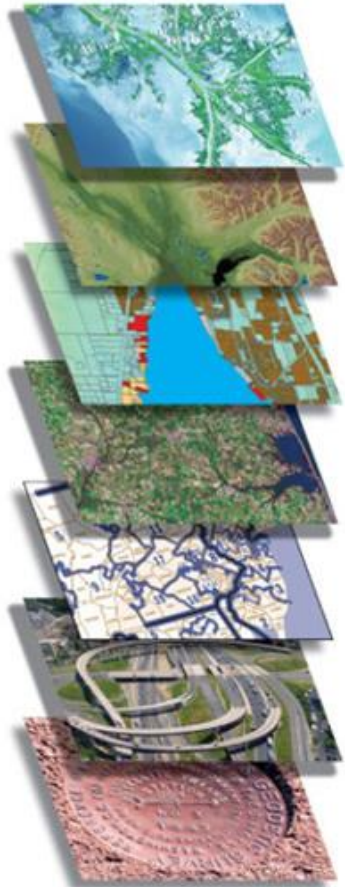

Elevation

Governmental Units

Cadastral (Parcels)

Land Cover

E911 Addresses

Transportation

Hydrography

Orthophotography

FGDC.GOV
FEDERAL GEOGRAPHIC DATA COMMITTEE



 **NSGIC**
National States Geographic Information Council

Use Case: Update of Census Master Address File

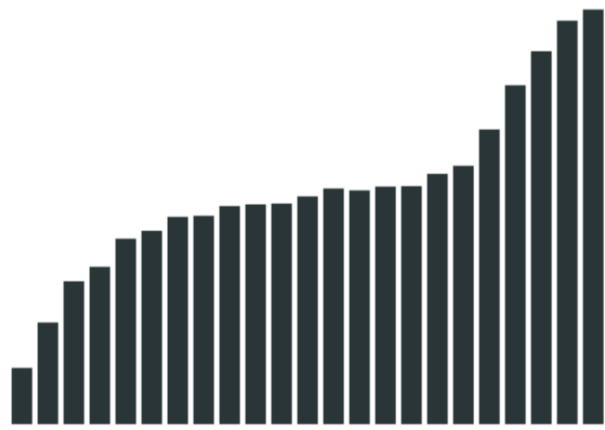

**The
High Cost
of a Low Count**

Why counting every person in Census 2020 matters and how we use imagery to help make that happen.

Process

Address Databases

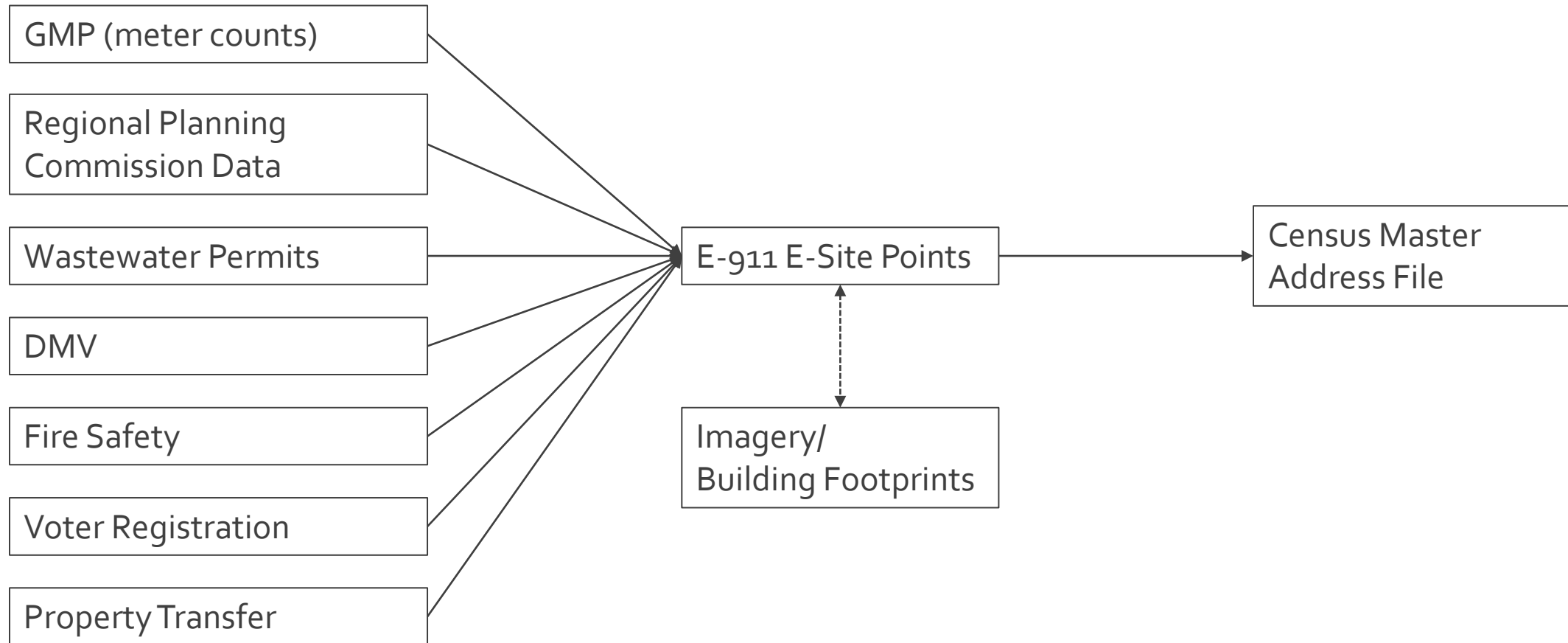

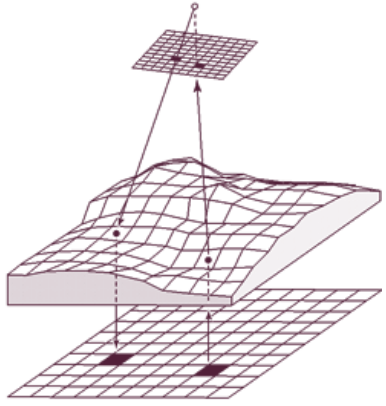

ORTHOIMAGERY

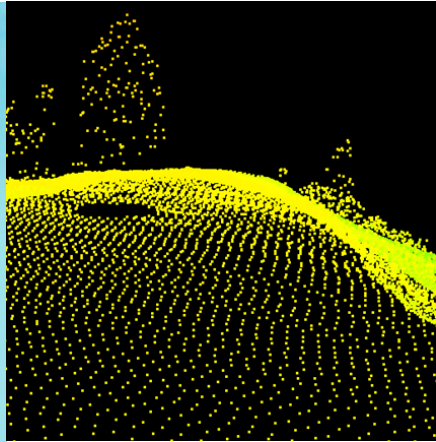
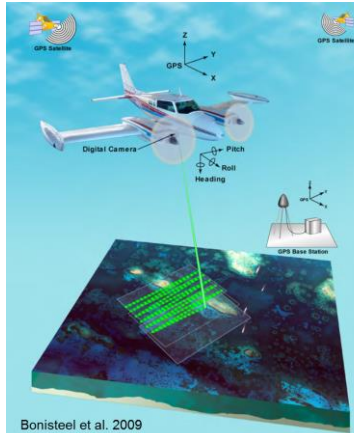

Bonisteel et al. 2009

LIDAR

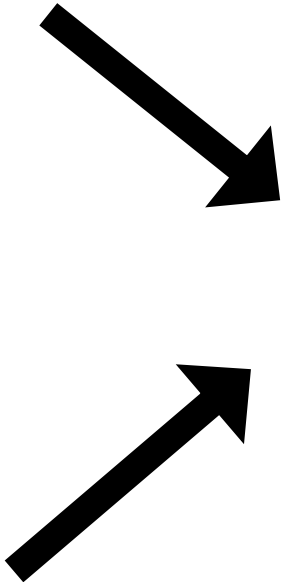

Land Cover



Building Footprint Extraction







**Missing E-911
Points**

Process

Address Databases

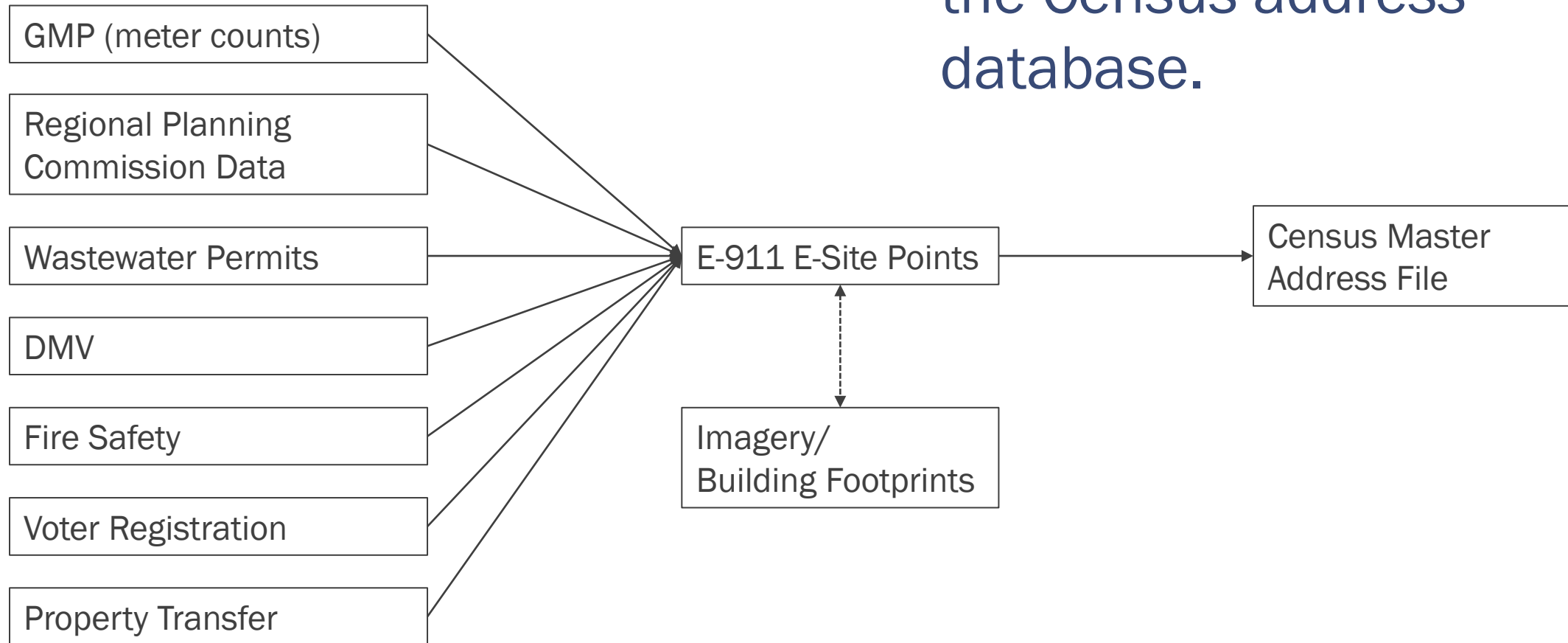

8634 homes added to the Census address database.

Counting for Dollars 2020

The Role of the Decennial Census in the Geographic Distribution of Federal Funds

COUNTING FOR DOLLARS 2020: VERMONT

Allocation of Funds from 55 Large Federal Spending Programs
Guided by Data Derived from the 2010 Census (Fiscal Year 2016)

Total Program Obligations: **\$2,482,076,315**

Program	Dept.	Obligations	Program	Dept.	Obligations
Financial Assistance Programs		\$2,442,326,777			
Medical Assistance Program (Medicaid)	HHS	\$1,072,721,000	Community Facilities Loans/Grants	USDA	\$12,643,300
Federal Direct Student Loans	ED	\$294,458,824	Supporting Effective Instruction State Grants	ED	\$10,640,019
Supplemental Nutrition Assistance Program	USDA	\$116,470,075	Crime Victim Assistance	DOJ	\$4,718,903
Medicare Suppl. Medical Insurance (Part B)	HHS	\$108,274,201	CDBG Entitlement Grants	HUD	\$724,881
Highway Planning and Construction	DOT	\$216,999,341	Public Housing Capital Fund	HUD	\$1,860,000
Federal Pell Grant Program	ED	\$36,600,000	Block Grants for the Prevention and Treatment of Substance Abuse	HHS	\$6,459,874
Section 8 Housing Choice Vouchers	HUD	\$53,056,000	Water and Waste Disposal Systems for Rural Communities	USDA	\$18,557,004
Temporary Assistance for Needy Families	HHS	\$47,353,181	Social Services Block Grant	HHS	\$3,095,990
Very Low to Moderate Income Housing Loans	USDA	\$75,986,637	Rural Rental Assistance Payments	USDA	\$11,110,509
Title I Grants to LEAs	ED	\$34,509,182	Business and Industry Loans	USDA	\$12,000,000
State Children's Health Insurance Program	HHS	\$29,299,000	Career and Technical Education - Basic Grants to States	ED	\$4,004,816
National School Lunch Program	USDA	\$15,358,000	Homeland Security Grant Program	DHS	\$3,981,689
Special Education Grants	ED	\$28,386,923	WIOA Dislocated Worker Grants	DOL	\$823,490
Section 8 Housing Assistance Payments Program	HUD	\$27,660,019	HOME	HUD	\$3,407,339
Federal Transit Formula Grants	DOT	\$26,249,000	State CDBG	HUD	\$6,418,887
Head Start	HHS	\$18,673,824	WIOA Youth Activities	DOL	\$2,139,306
WIC	USDA	\$13,591,000	WIOA Adult Activities	DOL	\$2,028,449
Title IV-E Foster Care	HHS	\$14,273,473	Employment Service/Wagner-Peyser	DOL	\$2,499,791
Health Care Centers	HHS	\$20,637,961	Community Services Block Grant	HHS	\$3,756,915
School Breakfast Program	USDA	\$5,700,000	Special Programs for the Aging, Title III, Part C, Nutrition Services	HHS	\$3,348,608
Rural Electrification Loans and Loan Guarantees	USDA	\$0	Cooperative Extension Service	USDA	\$2,399,454
Public and Indian Housing	HUD	\$3,472,000	Native Amer. Employment & Training	DOL	\$74,480
Low Income Home Energy Assistance	HHS	\$18,987,983			
Child and Adult Care Food Program	USDA	\$6,447,000	Federal Tax Expenditures		\$34,984,331
Vocational Rehabilitation Grants to the States	ED	\$11,990,345	Low Income Housing Tax Credit	Treas	\$16,786,224
Child Care Mandatory and Matching Funds	HHS	\$6,603,000	New Markets Tax Credit	Treas	\$18,198,107
Unemployment Insurance Administration	DOL	\$8,590,000			
Federal Transit - Capital Investment Grants	DOT	\$584,400	Federal Procurement Programs		\$4,765,207
Child Care and Development Block Grant	HHS	\$3,591,000	HUBZones Program	SBA	\$4,765,207
Adoption Assistance	HHS	\$9,109,704			

Prepared by Andrew Reamer, the George Washington Institute of Public Policy, the George Washington University. Spending data analysis provided by Sean Moulton, Open Government Program Manager, Project on Government Oversight. | January 30, 2019

Note: The sequence of the above programs is consistent with U.S. rank order by program expenditures. (See U.S. sheet in series.)

Counting for Dollars 2020 publications and spreadsheet with above data available at <https://gwipp.gwu.edu/counting-dollars-2020-role-decennial-census-geographic-distribution-federal-funds>

Federal Medical Assistance Percentage (FMAP)

U.S. Code › Title 42 › Chapter 7 › Subchapter XIX › § 1396d

$$FMAP = 1.00 - 0.45 \times \left(\frac{StatePCI}{U.S.PCI} \right)^2$$

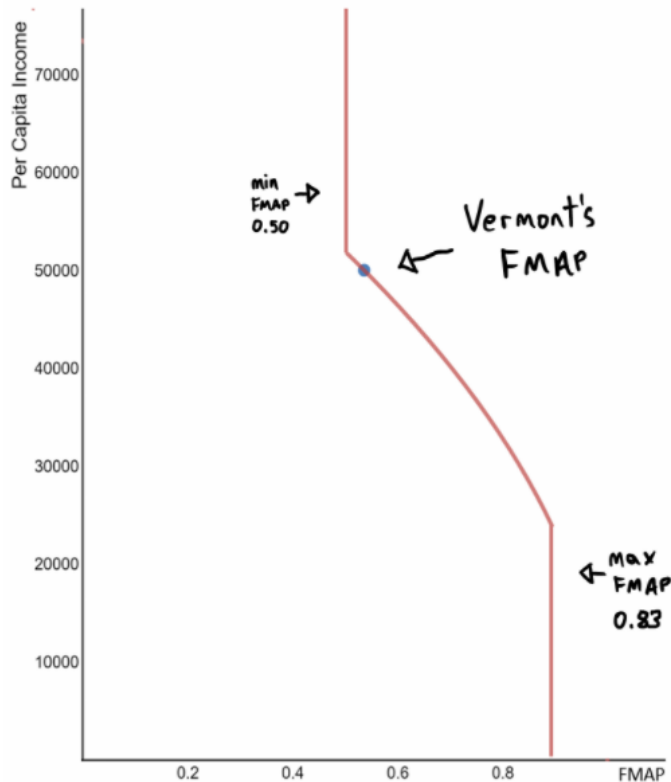

State Per
Capita
Income

=



Personal Income



Population



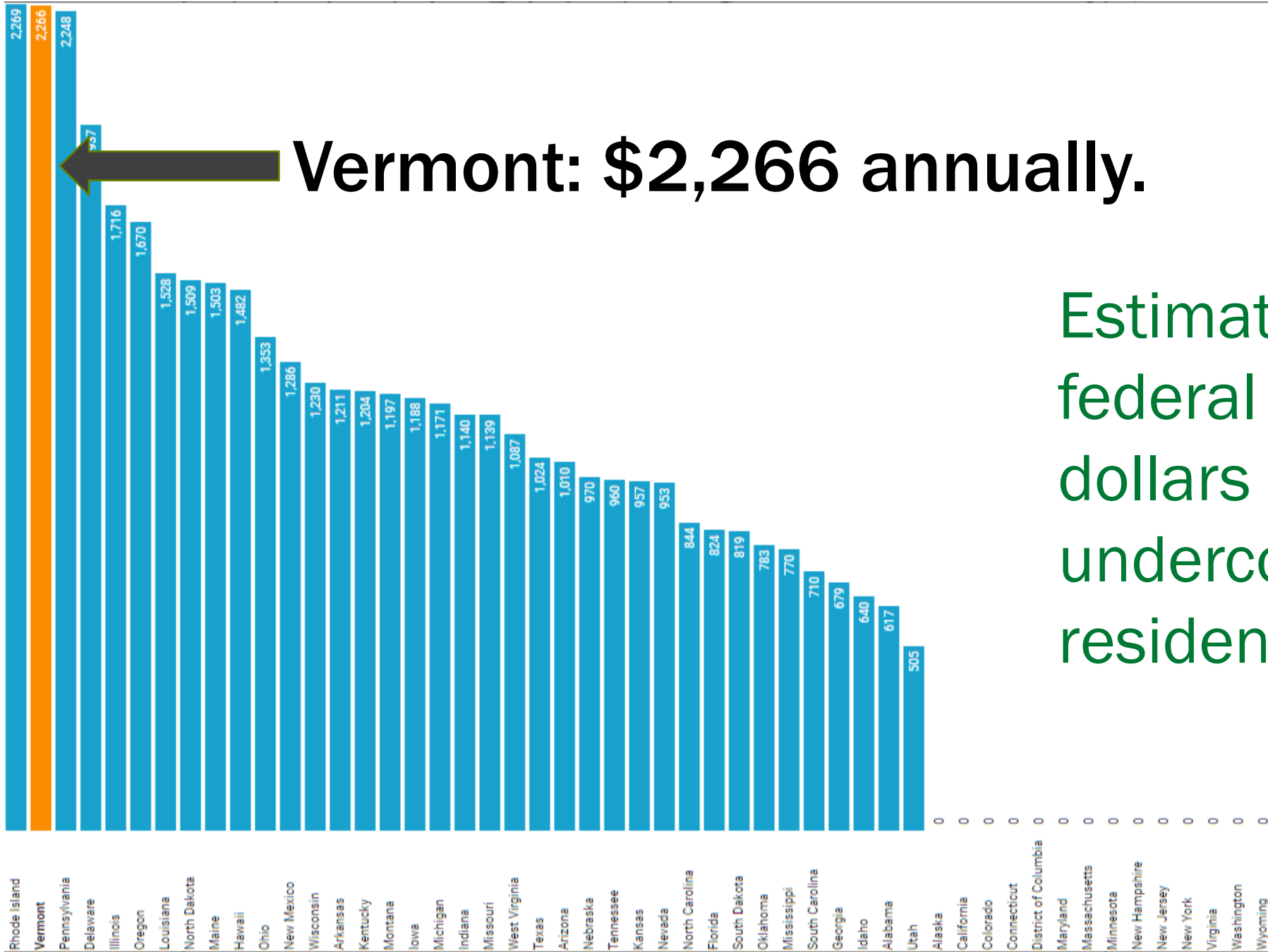

Vermont: \$2,266 annually.

Estimated cost in federal Medicaid dollars resulting from undercounting one resident

Estimated difference in federal Medicaid funds to Vermont resulting from the 8634 homes added to the census address database:

\$318 million dollars over ten years.

Read more here: <https://maps.vcgi.vermont.gov/HighCostLowCount>

Access Parcel Viewer with Orthoimagery (zoom in to see imagery)

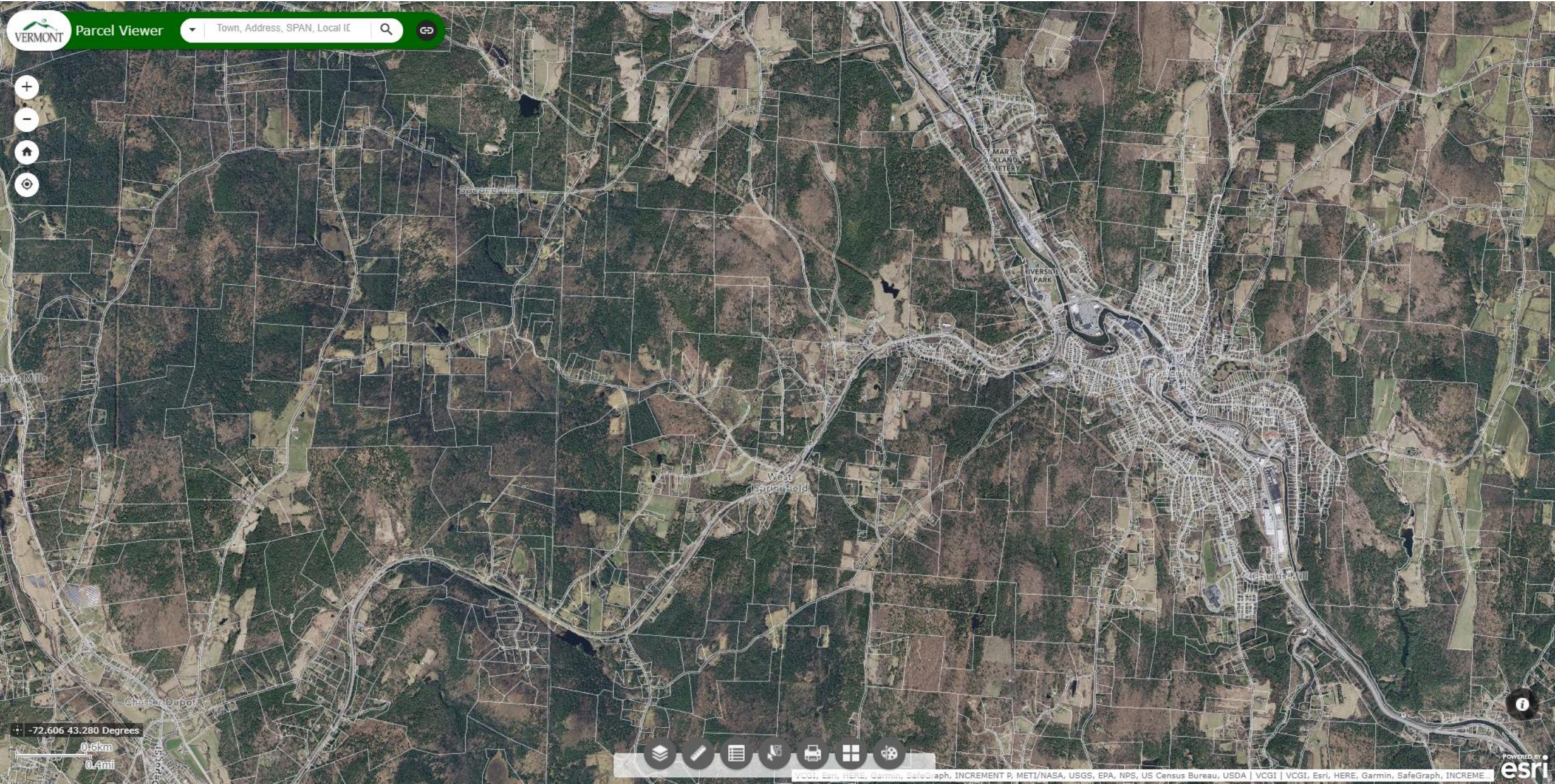

Learn More

- [2020 GIS Year in Review](#)
- [Interactive Map Viewer](#)
- [Tax Parcel Data Viewer](#)
- [Census: High Cost of a Low Count](#)
- [Historic Imagery](#)
- [Download Imagery](#)
- vcgi.vermont.gov

john.e.adams@vermont.gov

